

2021 PRICE LIST for Dressmaking and Bridalwear

STYLES

Highball / Halfball



Dome / Covered back



Canvas back



Ringed / Dual dome



Style	Sizes	Prices
Highball	18	48p
Halfball	14,16,18,20,22,24	48p
Dome	14,16,18,20,22,24,26,28,	45p
Dome	30,32,36,	55p
Dome	40,44,50	58p
Canvas back	14,16,18,20,22,24,28	60p
Canvas back	30,32,36,40,44	65p
Ringed dome (gold)	20,22,28,30,32,44	60p
Ringed dome (silver)	20,22,24,28,36,44	60p
Dual dome	24,28,32,36,40,44	70p
Rouleau Loops		85p
Eyelets		45p

ADDITIONAL CHARGES PER BUTTON AS REQUIRED

Backs covered in same fabric	15p
Centering of specific part of pattern	15p
Use of specific area of fabric pattern	10p
Aligning of shanks	15p
Overlining with lace, net or similar	10p

BUTTON COVERING SERVICES 01726 882325

SIZES

These are mould sizes.

Fabric thickness will increase size of button.

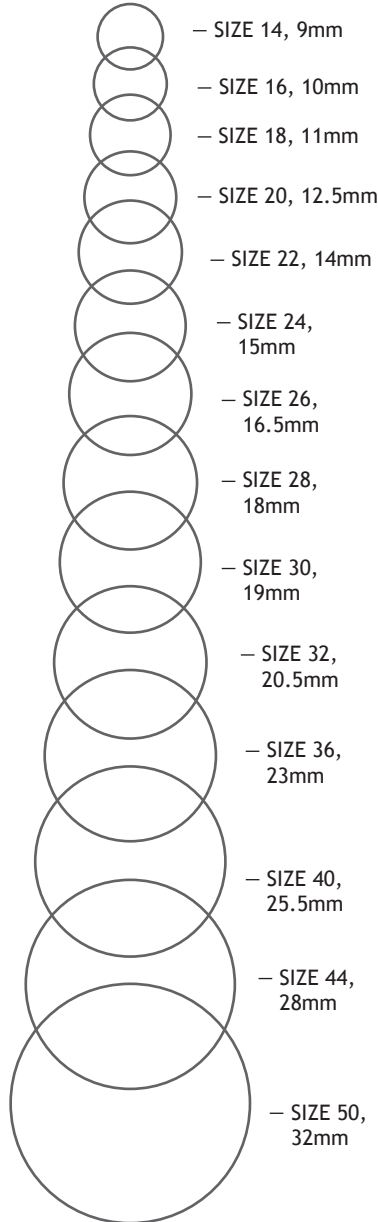

2021 ORDER FORM for Dressmaking and Bridalwear

Style of button	Size	White or black back	Gold or silver ring	Quantity	Price per button	Total price
Additional charges as required						
Administration, packing & carriage						£2.99
TOTAL						

Cheque enclosed made payable to **Button Covering Services**

Paid by BACS Account number: **25444188** Sort code: **09 01 27**

Name (Mr/Mrs/Miss/Ms)

Address

Postcode Telephone

Date

Please indicate which side of the fabric you wish to be the right side.
Fine fabrics will need to be supplied with a lining.

Send your completed order form and fabric to:

Button Covering Services, Middleton House, Trenowth, Grampound Road, Truro TR2 4EH

SPECIAL INSTRUCTIONS: (please continue overleaf if necessary)